

TermaTech
woodburning stoves
& accessories





.....

Art in pure lines - cosiness that warms up your room

.....

When the Termatech architects begin designing a stove, the starting point is that the aesthetic, quality and efficiency must work beautifully together. Your new wood burning stove is going to be the centre piece of your home for many years to come. It must be pleasing to your eye, the environment and light on your wallet.

Termatech continue to further Nordic designs with pride and care, taking form and function to a new level. The operation of the stove is well considered, the family budget as well as our responsibility to reduce carbon emissions from the beginning of the process.

Reasonable prices bring these beautiful designs to any home.



New: *
5 up to
years
warranty





TT22
*Serious heat,
 never looked
 so good*



TT22S

New: **5** up to years warranty

Your new beautiful heating unit, equipped with top plate and straight sides in soapstone.

Soapstone absorbs the heat slowly and gives off the accumulated heat long after the fire has died out.

Soapstone is a 100% natural product and its appearance varies from stove to stove.



TT22

New: **5** up to years warranty

The new TT22 is easy to operate, with a stay cool handle the beautiful design will last for many years.

If you are looking for a beautiful contemporary stove with a large heat output then please visit your local Termatech stove dealer.

Heat lovers will love TermaTech's new TT22 series. Timeless Danish design combined with high quality build and environmentally friendly combustion. Single handle air control makes it simple to manage the level of heat output and the flame height. You can burn the stove slowly with a 5kW heat output or work the stove harder with a high output, around 10kW. Options include: black or grey, steel or soapstone. The efficiency is even above 82%

Cool handle:
 The handle is ventilated and it's position means that it is always cool to the touch so you avoid burning your fingers.

Flexible design:
 If you want to change the look of your stove once installed then the soapstone covering can be added retrospectively to replace the steel and maximise the conversion of your fuel into heat.

Easy to operate:
 You can connect a direct air feed kit to the combustion chamber on the TT22 which may be necessary in new build properties or newly renovated homes to meet the building regulations.

Practical ash drawer:
 The ash drawer is large and easy to access when it needs emptying. A lid is included so that the ash can be removed securely.

Cast iron, where it makes a difference:
 Cast iron at the base of the chamber and a cast iron door ensures a long life for your stove and stability when the stove is under fire.

Well thought out combustion chamber:
 The deep combustion chamber centralises the flames in the stove for the perfect flame picture minimising the risk of embers or ash falling from the stove.



*TT20 The centre
of the home...
make the family
comfortable*



TermaTech TT20 is a newly developed range of stoves that combine the best operational comfort, with high product quality and sleek Scandinavian design.

And then there is the price. We have designed the TT20 to be a real 'people's stove' that is among the top stoves on the market for the price. Naturally the stoves fulfil the latest and most stringent European requirements: the efficiency is even above 83%.

5 variants—all designed with care and manufactured out of high quality materials. Regardless of the TT20 you choose, you can be sure of solid construction and well thought out design.

Flexible design:

Choose between straight or rounded steel sides, alternatively soapstone covering with straight or round sides. If you would like to give your stove a new look later on, then you can change the steel covering for soapstone covering.

Easy to operate:

It is easy to control the air for combustion. An air regulator, discretely placed under the cover does it all. You can connect fresh air/outdoor air directly to the combustion chamber on the TT20, which may be necessary in newly built or newly renovated homes.

Practical ash drawer:

The ash drawer is large and easy to access when it, at rare intervals, must be emptied. A lid is included, so that you can carry the ash out safely.

Cast iron, where it makes a difference:

Cast iron in the bottom and the door frame means a long life-span and stability in the door.

Well thought out combustion chamber:

The deep combustion chamber ensures that there are flames in the centre, while at the same time minimising the risk that embers and ash fall out.



Cast iron frame and bottom



Ergonomic and cool to the touch handle



Large ash drawer with cover



Air regulator

Cool handle:

The handle is ventilated and its position means that it is always cool to the touch so you avoid burning your fingers.

Wide range of accessories:

There is a wide range of accessories especially designed for the product range: Stainless glass blown ribs under the door, revolving and easily accessible door in the firewood storage compartment or the matching Firetool set (available as an optional extra).

TT20SA

New: **5** up to years warranty

New to the TT20 range is the TT20SA. If you love the look, feel and extra efficiency of soapstone but prefer a warmer look then this beautiful Indian sandstone is for you. The characteristics of the Indian sandstone are every bit as good as the soapstone but the appearance is very different. Visit your Termatech dealer to see the beautiful and different TT20SA. The TT20SA is available in black with sandstone.



The TermaTech TT 20

TT20

New: **5** up to years warranty

Is the base model in the range. It is equipped with straight steel sides and it is the slimmest stove in the product range. For those who want all of the TT20 advantages for an economic price. Operation of the stove is so completely simple that anyone can quickly and easily become familiar with it. The air intake has a single operating handle which gives immediate control.

TT20R

New: **5** up to years warranty

As the base model but equipped with rounded steel sides. The round sides create a harmonic unit that is suitable for both a straight wall or in a corner.

TT20S

New: **5** up to years warranty

Equipped with straight sides and top plate in soapstone. Soapstone absorbs the heat slowly and gives off the accumulated heat long after the fire has died out. Soapstone is a 100% natural product and its appearance varies from stove to stove.

TT20RS

New: **5** up to years warranty

Fitted with almost 80 kilos of rounded soapstone on the sides and top plate. The lavish amount of soapstone isn't just a beautiful cover, it ensures even more heat is absorbed and subsequently released than in other smaller soapstone stoves.





Fresh air connection

Newly built and very well-insulated houses are often airtight. Here it may be necessary to supply external air to the room where the stove is mounted. With a TT10, TT20 or TT22 this air (also called combustion air) can be supplied directly to the stove's air ducts through the matching fresh air connecting piece.

You will avoid having to open windows or vents and thus also avoid wasting heat.

TermaTech TT20 range accessories

A complete selection of beautiful accessories that make sense.

Give your new TT20 its own expression and make your daily life with the stove even easier.

TermaTech has designed accessories for the TT20 range that perfectly suit the beautiful lines of the stove. So you are sure that the aesthetics are in order and ease of operation has been thought through from the start.

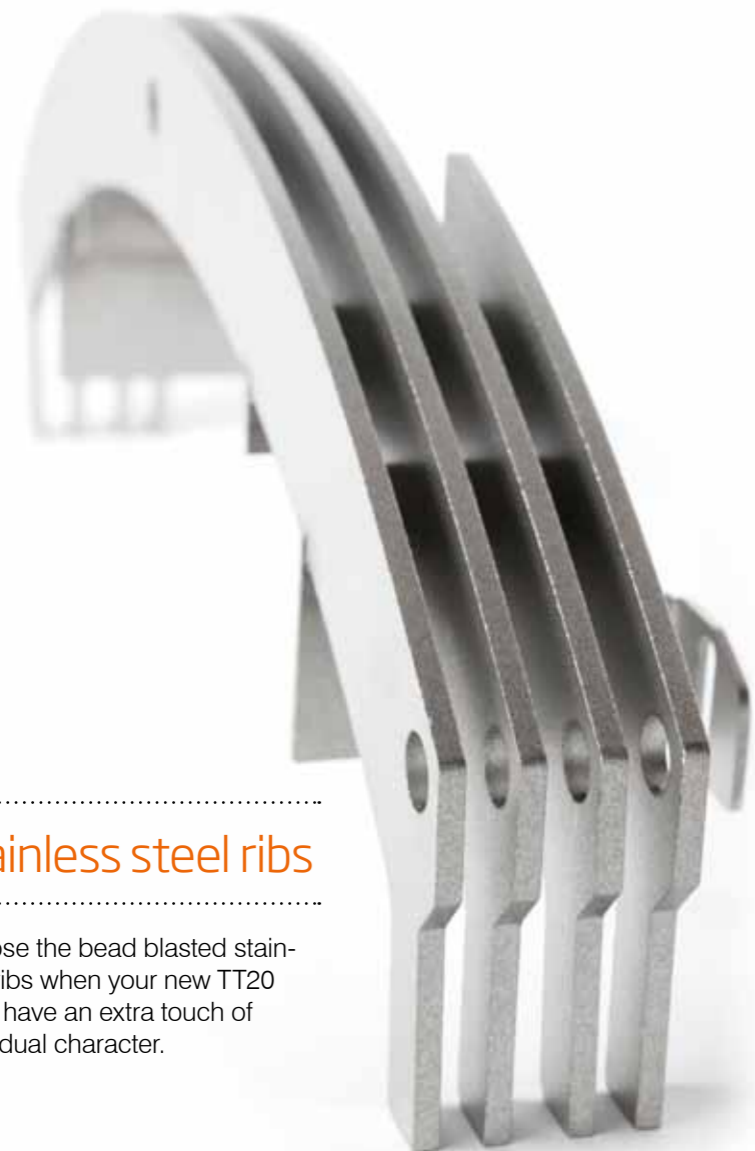

Stainless steel ribs

Choose the bead blasted stainless steel ribs when your new TT20 must have an extra touch of individual character.



Log grate

The log grate is an old invention that comes in a new and improved package. It ensures that neither the embers nor the wood fall out of the stove, even if you have put just a little too much wood on. It also minimises the risk of ash whirling out and ending up on the inside of the door.



Form cut glass plate

The glass plate gives a lighter expression and is easy to remove for cleaning. Can be removed outside of the season. Available in clear glass or black glass



360° Revolving door

If you want to complete the stove's beautiful lines and hide the accessories you often use with the stove, then the revolving door is an obvious choice. This door gives the stove a completely different look. It hides your igniter, gloves and other accessories that you do not want visible. As something new, you can choose a fireplace set comprised of a broom, shovel and poker that are discretely hidden in the revolving door.

Fireplace set

Turn the door 180° and you have easy access to everything you need to operate your stove: a good broom, a poker and a shovel. You will avoid having the space around your stove cluttered with accessories, as they are now an integrated part of the stove.

TT40 Design with focus on details

TermaTechs TT40 range are some of the most popular stoves on the market.

The design is timeless, the quality is top notch and the price is rock bottom. TT40 has a sensibly sized combustion chamber, ease of operation with only two air controls and a beautiful cast stainless steel handle.

There are hidden hinges and a curved front that completes the design. The door, bottom and log grate are made of cast iron, which guarantees stability and a long lifespan.

Naturally, the stoves are equipped with an efficient airwash, just as all the other TT models. The TT40 is available in 5 different variants, each capable of being the centre piece in any room setting.

Common to them all, however, is that they are stoves that live up to the most stringent environmental requirements, are easy to operate and are among the most reasonably priced quality stoves on the market.



Log store door





The TermaTech TT 40 range



TT40S

If you are on the lookout for a woodburning stove with soapstone and don't want to spend your entire life savings, then the TT40S is absolutely the most obvious investment. It has the same modern lines as the TT40R, however it is fitted with soapstone, which gives it a more rustic expression and at the same time stores heat longer than a steel stove.



TT40R

Is one of the latest new additions to the TT40 family. The stove is built in precisely the same way as the regular TT40; however, the sides are rounded. The rounded design makes, among other things, the stove well-suited for positioning in a corner.



TT40H

Is, together with the wall-hung model, one of the latest products in the TT40 range. The stove has been given a ledge on the top, which gives it a completely new and different design. The two soapstone pieces on the top of the stove come as standard. A door for the firewood storage compartment can be purchased separately.



TT40

A smart, yet simple, woodburning stove that meets all of the demands placed on a modern woodburning stove.

It has an elegant design with a young and modern look. The combustion is of the same high quality as in the other TT models, and pricewise it is completely in a class of its own. If you would like the front of the stove to be closed off then a door is available for the log store



TT40W

TT40W - A wall hung version of the popular TT40 that can also be installed in a chamber as a floor standing appliance. The design is lighter and allows you to focus on the flames in the chamber. If wall hanging the bottom edge of the stove must sit 260mm off the finished floor



TT10

panoramic view with character

The elegant TT10 range is comprised of 4 different models, all of which have quality, construction and design on a par with stoves that are significantly more expensive.

With the TT10 you get a proven woodburning stove, which has the same brilliant air control system as our newest models. The high, curved panoramic front allows the fire to be enjoyed from different angles. The door has a two-point closure, with cast iron in the bottom and in the door that ensures stability and a long life span.

Combustion wise the TT10 is exceptional. The TT10 is adjusted quickly and easily with the aid of a single control grip.

In newly built and especially well-insulated houses, it may be necessary to supply external air to the room where the stove is mounted. All TT10 models can be directly connected to fresh-air via the stove's air duct, so heat is not wasted through open windows or vents.

The TermaTech TT 10 range



TT10

Is the base model in the range.

It is equipped with rounded steel sides.

An accomplished design with the curved panoramic front means the fire can be viewed from several angles.



TT10S

Equipped with an elegant and solid soapstone covering.

As soapstone is a natural product, no two stoves are completely alike - your stove is totally unique. Soapstone absorbs the heat slowly and gives off the accumulated heat long after the fire has died out.



Fresh air connecting

Newly built and very well-insulated houses are often airtight. Here it may be necessary to supply external air to the room where the stove is mounted. With a TT10, this air (also called combustion air) can be supplied directly to the stove's air ducts through the matching fresh air connecting piece.

You will avoid having to open windows or vents and thus also avoid wasting heat.



TT10HS

The top model in the popular and elegant TT10 series, which meets the most stringent environmental requirements in Europe. The stove has a heating compartment that keeps your coffee warm while spreading a cosy atmosphere. The soapstone keeps the room warm, as it stores the heat and emits it slowly.



TT10G

The two extra glass panels on the sides of the stove allow the fire to be enjoyed from any angle. TT10G is the shining focal point in the room.



*TT1 and TT3
... creating a
brilliant atmosphere
for the entire family*



TermaTech TT1 & TT3 ranges

*Complete your
stove with our
beautiful
accessories*



TermaTech accessories

TermaTech is a full service supplier of everything for the woodburning stove.

At your professional stove dealer you will find TermaTech's wide range of accessories for your woodburning stove. It begins with the hearth under the woodburning stove and ends with the rain cap at the top of the chimney. Shown below is only a selection of TermaTech's range of accessories, which includes: pipes, hearths, fire tools, wood baskets, stainless steel chimneys, firestarters, extractors and much more.



TT1Z

TT1Z is the small economic stove for smaller rooms. The same well-functioning combustion chamber as the TT1, but in a slightly simpler construction.



TT3S

TT3S is mounted with a beautiful and solid soapstone covering on the sides and the top.

The TT3S combines simple design with soapstone's rustic appearance and heat emitting properties.



TT3HS

TT3HS is a further development of the popular TT3S. Both the heating compartment, sides and top are in soapstone. The beautiful soapstone also helps to store the heat and gives it off slowly after the fire has died out.

All this in a tall and powerful stove with many possibilities.



Crocodile tool

The best fire tong on the market.



Moisture meter

Wet wood can impair your stoves performance, efficiency and the environment.

Firetool "Edge 1"



TermaTech accessories



Firetool "Edge 3"

Wall hanging tool set to complete the contemporary look of your stove and keep the look of your stove beautifully simple

All you need is fire...



Biofirestarters

Wax covered wood shaving that effortlessly light your stove with just one firelighter and environmentally sound



Rubber or eco leather - cylinders for firestarters



Firewood is beautiful...



TermaTech accessories

TermaTech fireside accessories to complete the look of your stove with simple clean lines and contemporary style. Baskets made of rubber, felt, leather or steel helps you to carry your wood inside, keep your livingroom clean and on top of it, it looks great.

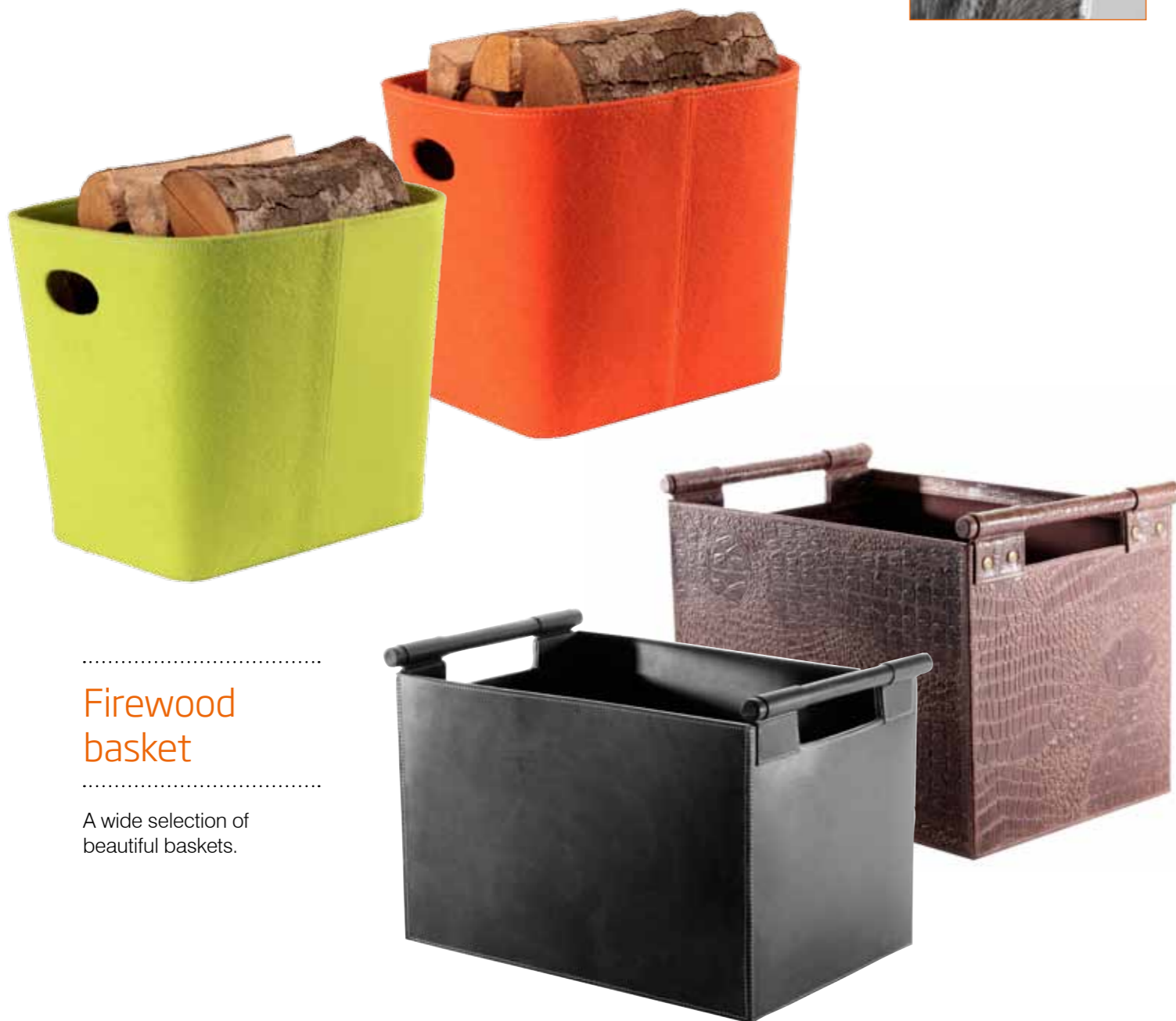

Firewood basket

A wide selection of beautiful baskets.



TermaTech information

General information about the TT models

- Are tested and approved by recognised European testing institutes
- Are effective and high build quality
- Are constructed with a view to easy and error-free operation
- Are constructed so that there is a minimum of maintenance and the wearing parts are easy to replace
- Are convection stoves, thus ensuring better heat distribution. Heats up between 30 and 160m²
- Are equipped with a efficient airwash that keeps the glass clean
- Are equipped with cast iron frames in the door and bottom of the combustion chamber
- Are equipped with stainless steel door handles
- Can be supplied in either metallic grey or black
- Can be connected from the back or the top
- Can be purchased from your professional stove shop, which ensures you receive the correct advice, optimal guidance and proper installation

The qualities above assume that the user follows the firing guidelines and solely uses clean and dry firewood in the stove.

On TermaTech's website you can easily locate your closest dealer. Here you will find usage instructions, the statutory test certificate and all technical data on the stoves.

We wish you and your family many cosy and warm times in the company of your new TermaTech woodburning stove.

*Please read our conditions for "up to 5 years warranty" in our user and mounting manual. (only the TT20 and TT22)

Approvals and environment

TermaTech's woodburning stoves are approved after and meet the most stringent requirements in Europe. They are approved by, among others, Rhein Ruhr Feuerstätten Prüfstelle and The Danish Technological Institute who have completed the CE-approval (EN13240), the Austrian standard "15A" and the German standard "DIN+". The stoves are also tested and approved by SINTEF, which is a Norwegian testing institute and VKF, which is a Swiss institute. In England, all of the stoves are tested and approved by HETAS. Several of TermaTech's models also feature the Swan ecolabel. See the technical data for further details.



Member of:



New: *
5 up to
 years
 warranty

Air flow

All of TermaTech's woodburning stoves are convection stoves. This means that there is an inner shell and an outer shell. The air between the two shells quickly becomes heated, rises upward and is distributed faster throughout the entire room. The stove takes in cool air from the bottom, heats it up and then the air is distributed at the top of the stove.

The difference between a well-functioning convection stove and a radiant heater is that with a convection stove you achieve a better and more uniform heat distribution in the room.

The convection stove is also less warm on the outer surfaces.

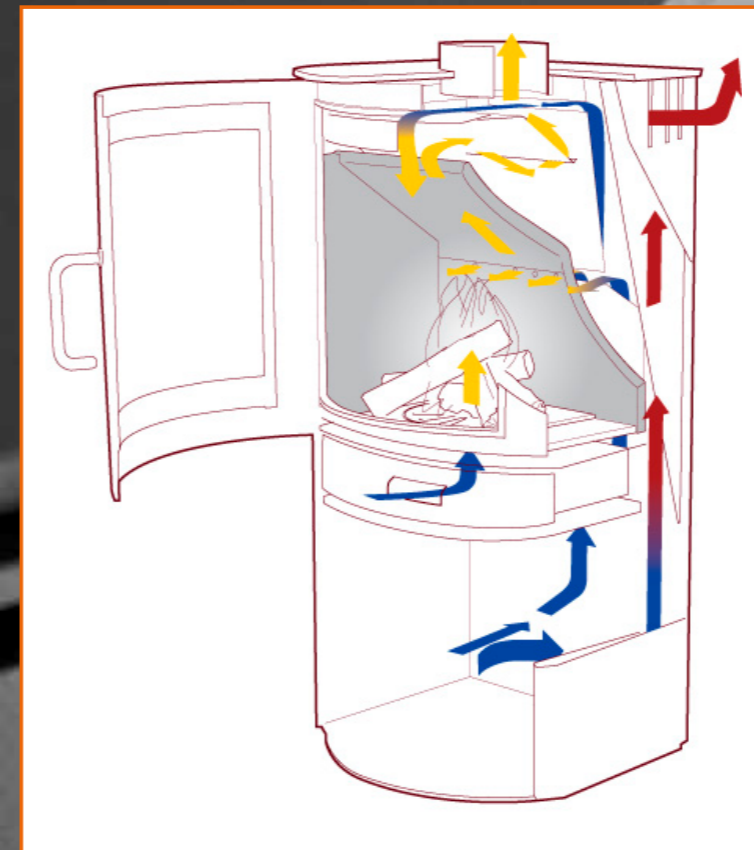

TT1-3 ranges

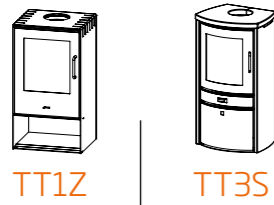

	TT1Z	TT3S
Nominal effect in kW	6	6
Operating range in kW	4 - 8	4 - 8
Efficiency %	78	78
Heats m ²	30 - 140	30 - 140
Weight in kg	107	122
Fresh air connection possible	○	○
Convection stove	●	●
Airwash	●	●
Ash drawer	●	●
Control handle	2	2
Connection at the top or rear	●	●
Colours Grey/Black	●/●	●/●
H / B / D	878/478/410	1016/546/468
AT / AB	149/740	163/842
GB / GH	325/360	315/363
FU / FB	0 / 0	0 / 0
Flue pipe connection diameter	150	150
Combustion chamber width/depth	340/298	340/316
Behind the stove	100	100
Behind the stove with insulated pipe	100	100
To the side	150	150
To the side with insulated pipe	150	150
With 45° corner setup	150	150
With 45° corner setup with insulated pipe	150	150
Furnishing distance front	900	900
Accessories	○	○
Approvals	CE/EN 13240, SINTEF, HETAS, test certificate, DINplus, VKF, 15A, Luftreinhalte Verordnung Schweiz, 1. Stufe der Bundes-Immissionsschutzverordnung	
Comments		

Dimensions

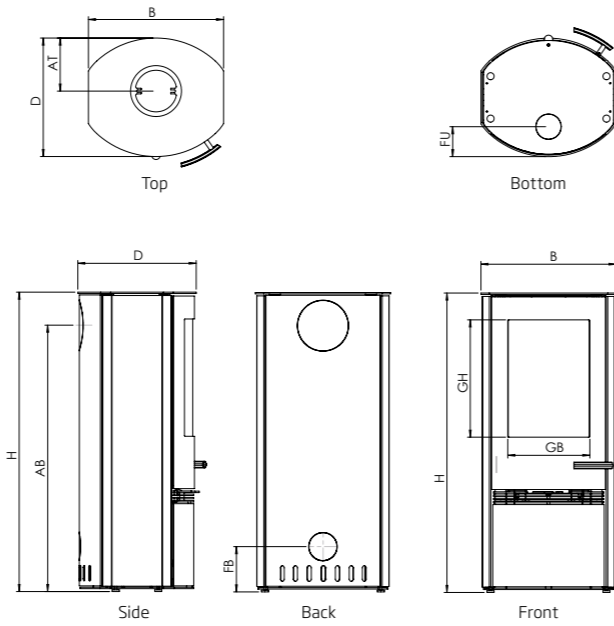

TermaTech take no responsibilities for amendments or omissions from this data

● Possible ○ Not possible

TT20 ranges

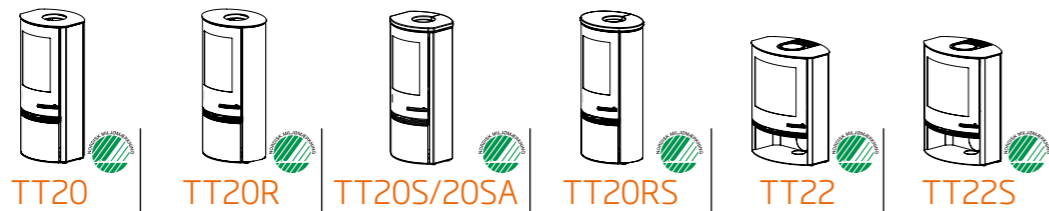

	TT20	TT20R	TT20S/20SA	TT20RS	TT22	TT22S
Nominal effect in kW	5	5	5	5	7,5	7,5
Operating range in kW	3 - 7	3 - 7	3 - 7	3 - 7	5-10	5-10
Efficiency %	83.4	83.4	83.4	83.4	82	82
Heats m ²	30 - 120	30 - 120	30 - 120	30 - 120	40 - 160	40 - 160
Weight in kg	118	118	150	183	175	208
Fresh air connection possible	●	●	●	●	●	●
Convection stove	●	●	●	●	●	●
Airwash	●	●	●	●	●	●
Ash drawer	●	●	●	●	●	●
Control handle	1	1	1	1	1	1
Connection at the top or rear	●	●	●	●	●	●
Colours Grey/Black	●/●	●/●	●/●	●/●	●/●	●/●
5 years warranty*	●	●	●	●	●	●
H / B / D	1053/478/419	1053/531/419	1088/470/419	1088/531/419	929/708/482	969/708/482
AT / AB	188/942	188/942	193/942	193/942	219/812	219/812
GB / GH	287/415	287/415	287/415	287/415	470/423	470/423
FU / FB	106/160	106/160	106/160	106/160	146/100	146/100
Flue pipe connection diameter	150	150	150	150	150	150
Combustion chamber width/depth	340/271	340/271	340/271	340/271	570/300	570/300
Behind the stove	150	150	150	150	150	150
Behind the stove with insulated pipe	100	100	100	100	50	50
To the side	350	350	350	350	450	450
To the side with insulated pipe	350	350	350	350	450	450
With 45° corner setup	125	125	125	125	150	150
With 45° corner setup with insulated pipe	100	100	100	100	150	150
Furnishing distance front	1000	1000	1000	1000	1200	1200
Accessories	Lower door, fireplace set, stainless ribs, log grate, soapstone top **, form cut glass plate, feet				○	Cooking plate set
Approvals	CE/EN 13240, SINTEF, HETAS, The Swan Ecolabel, test certificate, DINplus, VKF, 15A, Luftreinhalte Verordnung Switzerland, 1.+ 2. Stufe der Bundes-Immissionsschutzverordnung, Munich, Regensburg, Stuttgart, Aachen. 5 years warranty* see more at page 24					
Comments	** Soapstone only TT20R					

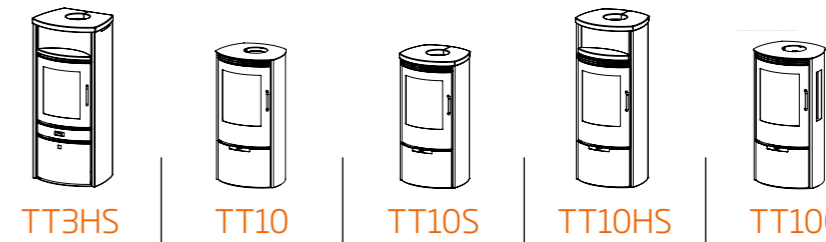

TT10 ranges

	TT3HS	TT10	TT10S	TT10HS	TT10G	
Nominal effect in kW	6	6	6	6	6	Nominal effect in kW
Operating range in kW	4 - 8	3 - 8	3 - 8	3 - 8	3 - 8	Operating range in kW
Efficiency %	78	82	82	82	82	Efficiency %
Heats m ²	30 - 140	30 - 140	30 - 140	30 - 140	30 - 140	Heats m ²
Weight in kg	217	111	205	211	108	Weight in kg
Fresh air connection possible	○	●	●	●	●	Fresh air connection possible
Convection stove	●	●	●	●	●	Convection stove
Airwash	●	●	●	●	●	Airwash
Ash drawer	●	●	●	●	●	Ash drawer
Control handle	2	1	1	1	1	Control handle
Connection at the top or rear	●	●	●	●	●	Connection at the top or rear
Colours Grey/Black	●/●	●/●	●/●	●/●	●/●	Colours Grey/Black
H / B / D	1238/546/468	1009/518/462	1044/525/485	1279/525/490	1009/518/462	H / B / D
AT / AB	163/842	184/840	210/840	215/840	187/840	AT / AB
GB / GH	315/363	333/400	333/400	333/400	333/400	GB / GH
FU / FB	0 / 0	95/104	95/104	95/104	95/104	FU / FB
Flue pipe connection diameter	150	150	150	150	150	Flue pipe connection diameter
Combustion chamber width/depth	340/316	340/309	340/309	340/309	340/309	Combustion chamber width/depth
Behind the stove	100	100	100	100	100	Behind the stove
Behind the stove with insulated pipe	100	100	100	100	100	Behind the stove with insulated pipe
To the side	150	200	200	200	450	To the side
To the side with insulated pipe	150	200	200	200	450	To the side with insulated pipe
With 45° corner setup	150	100	100	100	150	With 45° corner setup
With 45° corner setup with insulated pipe	150	100	100	100	150	With 45° corner setup with insulated pipe
Furnishing distance front	900	900	900	900	900	Furnishing distance front
Accessories	○	Soapstone top	○	○	Soapstone top	Accessories
Approvals	See TT3S					CE/EN 13240, SINTEF, HETAS, test certificate, DINplus, VKF, 15A, Luftreinhalte Verordnung Schweiz, 1.+ 2. Stufe der Bundes-Immissionsschutzverordnung, München, Regensburg, Stuttgart, Aachen
Comments						Min. 260mm above the floor

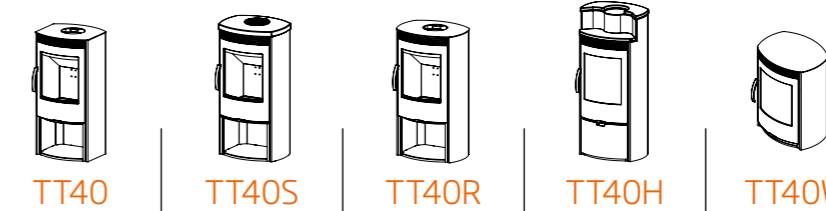

TT40 ranges

	TT40	TT40S	TT40R	TT40H	TT40W	
Nominal effect in kW	5	5	5	5	5	Nominal effect in kW
Operating range in kW	3 - 7	3 - 7	3 - 7	3 - 7	3 - 7	Operating range in kW
Efficiency %	79.7	79.7	79.7	79.7	79.7	Efficiency %
Heats m ²	30 - 120	30 - 120	30 - 120	30 - 120	30 - 120	Heats m ²
Weight in kg	115	167	118	135	100	Weight in kg
Fresh air connection possible	○	○	○	○	○	Fresh air connection possible
Convection stove	●	●	●	●	●	Convection stove
Airwash	●	●	●	●	●	Airwash
Ash drawer	●	●	●	●	●	Ash drawer
Control handle	2	2	2	2	2	Control handle
Connection at the top or rear	●	●	●	●	●	Connection at the top or rear
Colours Grey/Black	●/●	●/●	●/●	●/●	●/●	Colours Grey/Black
H / B / D	953/458/414	988/498/416	955/520/414	1148/520/414	702/520/414	H / B / D
AT / AB	174/788	173/788	175/788	175/788	0/540	AT / AB
GB / GH	325/363	325/363	325/363	325/363	325/363	GB / GH
FU / FB	0 / 0	0 / 0	0 / 0	0 / 0	0 / 0	FU / FB
Flue pipe connection diameter	150	150	150	150	150	Flue pipe connection diameter
Combustion chamber width/depth	340/212	340/212	340/212	340/212	340/212	Combustion chamber width/depth
Behind the stove	100	100	100	100	100	Behind the stove
Behind the stove with insulated pipe	100	100	100	100	100	Behind the stove with insulated pipe
To the side	200	200	200	200	200	To the side
To the side with insulated pipe	200	200	200	200	200	To the side with insulated pipe
With 45° corner setup	100	100	100	100	100	With 45° corner setup
With 45° corner setup with insulated pipe	100	100	100	100	100	With 45° corner setup with insulated pipe
Furnishing distance front	900	900	900	900	900	Furnishing distance front
Accessories	Log store door	Log store door	Log store door	Log store door	○	Accessories
Approvals	CE/EN 13240, SINTEF, HETAS, test certificate, DINplus, VKF, 15A, Luftreinhalte Verordnung Schweiz, 1.+ 2. Stufe der Bundes-Immissionsschutzverordnung, München, Regensburg, Stuttgart, Aachen					
Comments						Min. 260mm above the floor



TermaTech AS · DK-8361 Hasselager · www.termatech.com

